

5

4

3

2

1

REVISION RECORD		
LTR	ECO NO:	APPROVED DATE:
W		

### VIPRE POWER SUPPLY BOARD

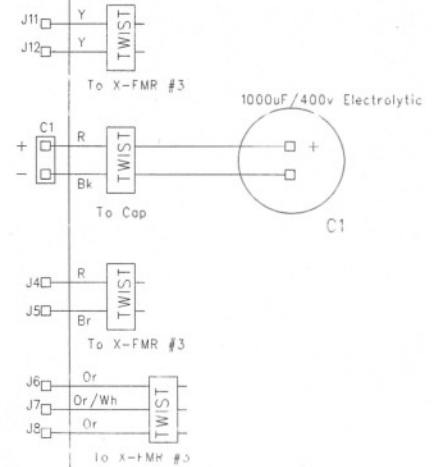
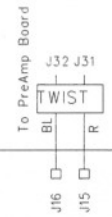
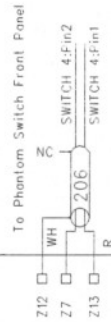
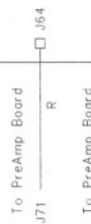
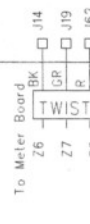
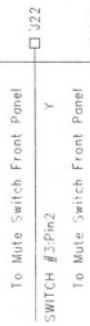
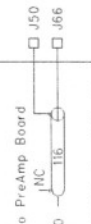
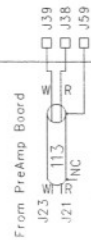
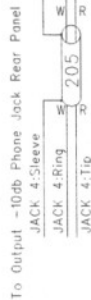
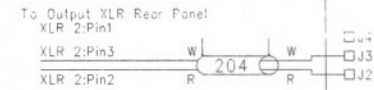
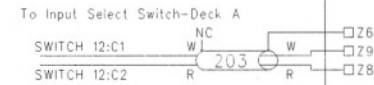
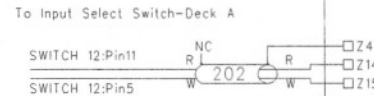
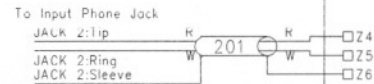
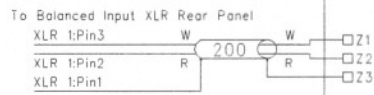

COMPANY: GT ELECTRONICS	
TITLE: VIPRE POWER SUPPLY BOARD	
PART NUMBER:	REV:
ASSY NUMBER:	SIZE: C
FILENAME: blockn.pch	SCALE:
SHEET: 3 OF 10	

DRAWN: D.Sierer	DATED: 22 AUG 00
RELEASED:	DATED: